

°LAUDA

°LAUDA



OVERALL BROCHURE CONSTANT TEMPERATURE EQUIPMENT 2020/2021

°FAHRENHEIT. °CELSIUS. °LAUDA.

LAUDA

HEATING THERMOSTATS



Specific application examples

- Sample preparation for chemical and pharmaceutical analysis
- Medical serology
- Biotechnology
- Material testing

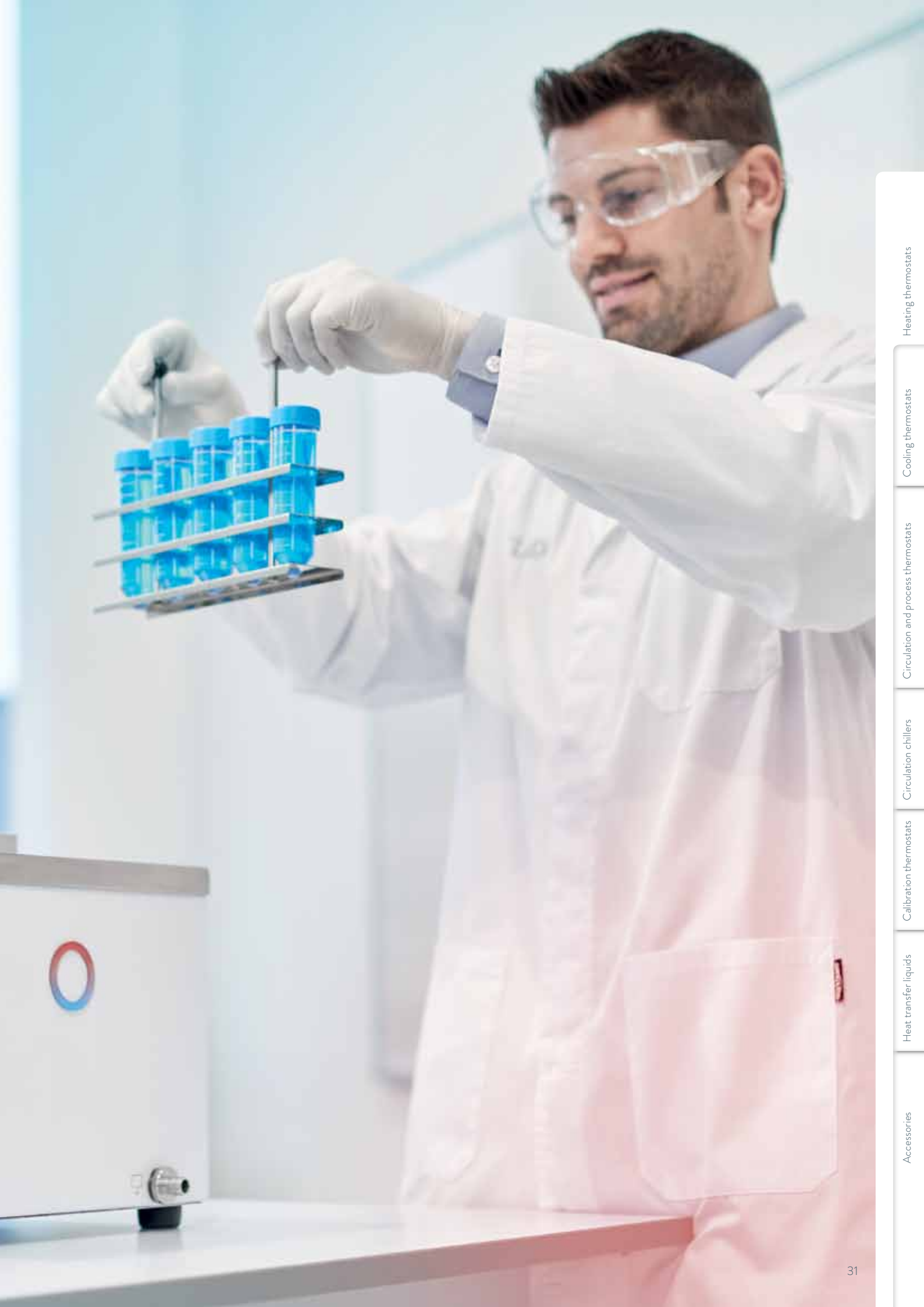

Heating thermostats

Cooling thermostats

Circulation and process thermostats

Circulation chillers

Calibration thermostats

Heat transfer liquids

Accessories

LAUDA Alpha

Heating thermostats from 25 to 100 °C for cost-effective temperature control thermostating in the lab

25°C ————— 100°C

Cost-effective thermostats with reliable technology incorporated into a modern design

LAUDA Alpha is the most cost-effective choice when it comes to premium-quality LAUDA thermostats. These reliable and user-friendly thermostats, with features optimized for essential use, can be operated with non-flammable liquids and are suitable for both internal and external temperature control tasks.



Simple and intuitive menu navigation with three-button operation using a large, clearly legible LED display



Screw clamp allows easy change to different bath vessels with a maximum wall thickness of 30 mm

HEATING PERFORMANCE Water, bath closed

Bath temperature °C

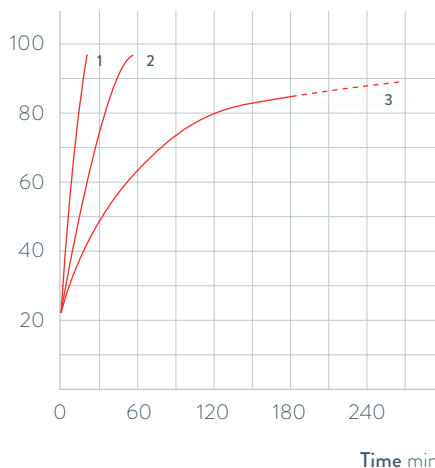

1 A6
2 A12
3 A24

Important functions

- Deep-drawn stainless steel bath vessels
- Integrated timer function allows automatic device shutdown
- Low-level and overtemperature protection for operation with non-flammable liquids

Included accessories

Screw clamp, attachment nozzle in two sizes

Further accessories

Pump circulation set, cooling coil, bath cover set

All technical data and power supply variants can be found in the ›Technical data‹ section.

More at www.lauda.de/1724



LAUDA Alpha

Heating thermostats A6, A12 and A24 work in the temperature range between 25 and 100 °C. Cooling coil, pump circulation set and bath cover set are available as accessories for all thermostats.



LAUDA ECO

Heating thermostats from 20 to 200 °C
for economic temperature control in the lab



Economic and high-performance temperature control

The ECO thermostats come in Silver (LCD display) or Gold (color TFT display) models, equipped with a mini USB interface as standard. The circulation pump can be adjusted to six levels. The ECO heating thermostat line encompasses transparent baths up to 100 °C as well as immersion thermostats and heating thermostats with stainless steel baths up to 200 °C.



Plain text menu navigation on a monochrome LCD (Silver) or color TFT display (Gold) for easy operation



Standard-issue cooling coil included with all heating thermostats

HEATING PERFORMANCE Heat transfer liquid: Therm 240, bath closed

Bath temperature °C

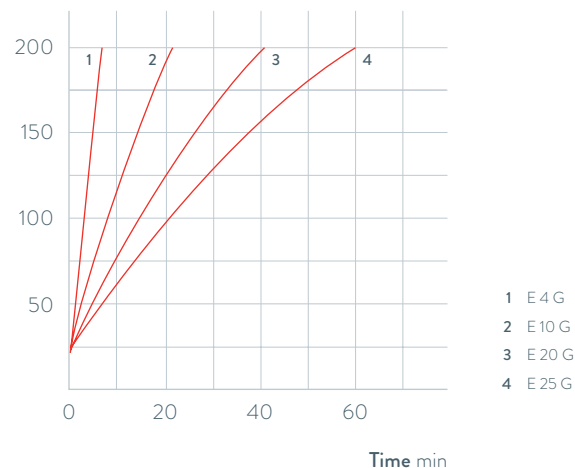

- 1 E 4 G
- 2 E 10 G
- 3 E 20 G
- 4 E 25 G

Important functions

- Integrated programmer for automating temperature profiles
- Adjustment of flow rate switch for internal/external circulation, can be controlled from exterior during operation
- Can be upgraded with Pt100/LiBus module for external control

Included accessories

Cooling coil, bath cover and pump connections (with E 4)

Further accessories

Tubing, bath cover, pump connection set, interface modules

All technical data and power supply variants can be found in the ›Technical data‹ section.

More at www.lauda.de/1726



LAUDA ECO

Bath thermostats come equipped with a cooling coil as standard. The E4 is also equipped with a bath cover and pump connections for external application connections. A drain tap on the back side of the device makes changing the heat transfer liquid in the stainless steel baths easy and safe.



LAUDA PRO

Heating bath thermostats from 30 to 250 °C
for professional temperature control



Flexible operation, outstanding performance characteristics

LAUDA PRO is the cutting-edge product line with an outstanding overall concept: The innovative Base or Command Touch operating units can be detached and used as a remote control. Heating bath thermostats come equipped with a cooling coil as standard.



Low device height and 360° accessibility of the bath thanks to detachable remote control



Ethernet and USB interface and Pt100 connection as standard

HEATING PERFORMANCE Heat transfer liquid: Ultra 300, bath closed

Bath temperature °C

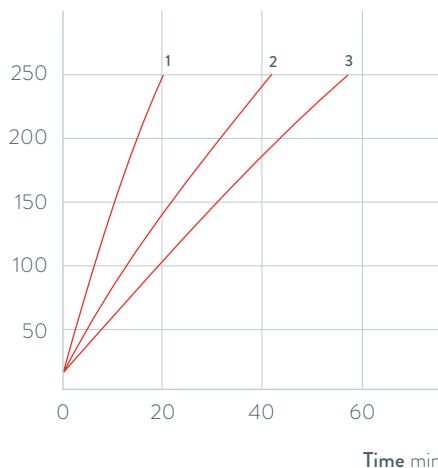

- 1 P10 C
- 2 P20 C
- 3 P30 C

Important functions

- Draining tap on the front of the device
- Operated via Base operating unit with OLED display or Command Touch with color touch screen
- Stainless steel bath vessels (insulated with handles and drain tap)
- Internal LAUDA Vario Pump with 8 selectable output levels
- Ethernet and USB interface and Pt100 connection as standard

Included accessories

Bath cover, tubing nipples with screw caps for the cooling coil

Further accessories

External pump, interface modules

All technical data and power supply variants can be found in the »Technical data« section.

More at www.lauda.de/1728



LAUDA PRO

The PRO heating bath thermostats P10, P20 and P30, with volumes of 10, 20 and 30 liters, function up to a maximum temperature of 250 °C and their excellent temperature stability make them perfect for internal bath applications.



LAUDA Proline bridge thermostats

Bridge thermostats 30 to 300 °C
for temperature control of any bath



Intuitive operation with broad temperature range

The LAUDA Proline bridge thermostats with vario flex pump are great for temperature control of any bath vessel. The PB models have a pressure/suction pump, but the PBD models are equipped with stronger pressure pumps. They enable temperature control on deeper baths of up to 320 mm. A telescoping rod for baths with a width of 310 to 550 mm, an ergonomic handle and side pump connections are also available.

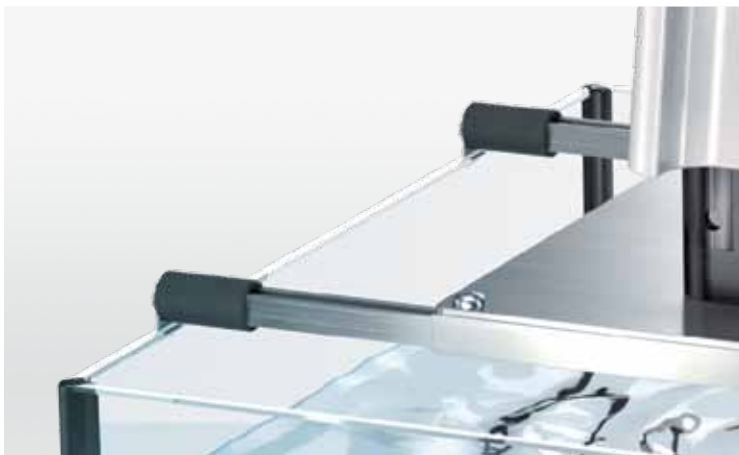

Extendable telescoping rods for placement on baths with widths of 310 to 550 mm



Removable Command remote control unit for easy and intuitive operation

PUMP CHARACTERISTICS for PBD and PBD C, Liquid: Water

Pressure bar

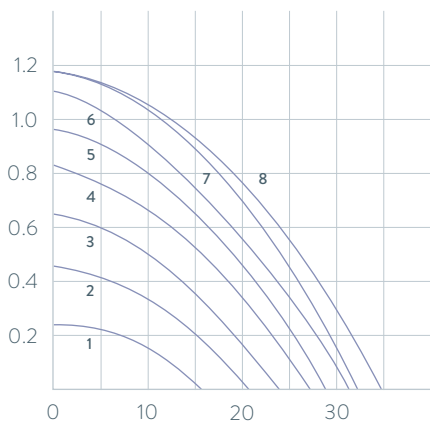

- 1 Step 1
- 2 Step 2
- 3 Step 3
- 4 Step 4
- 5 Step 5
- 6 Step 6
- 7 Step 7
- 8 Step 8

Pump flow L/min

Important functions

- Programmer with 150 temperature/time segments and graphical temperature display with Command control unit
- PowerAdapt system for optimally adapted max. heating output without influencing the mains power supply
- Low-level protection and adjustable overtemperature protection with acoustic alarm. Float for identifying low or high level

Included accessories

Tubing nipples for pump connection, telescoping rod

Further accessories

Automatic filling device, bath vessels, interface modules

All technical data and power supply variants can be found in the ›Technical data‹ section.

More at www.lauda.de/1730



LAUDA Proline bridge thermostats

LAUDA Proline bridge thermostats are available with two different control units. The master version is designed for all applications in which the parameters are not changed very often. The removable Command operating unit offers a graphic LCD screen for high operating convenience and an additional programmer.



LAUDA Proline clear-view thermostats

Heating clear-view thermostats from 30 to 230 °C
in research, application technology and production

30°C 230°C

A clear view of the object at all times

LAUDA clear-view thermostats are optimized for direct observation of objects. They are ideal for use with the fully automatic LAUDA viscometer PVS or iVisc, since the temporal and spacial temperature stability necessary for precise determination of viscosity is guaranteed across the whole temperature range. Furthermore, the two-chamber principle ensures a constant liquid level in the measuring chamber at all times, regardless of the fluid volume and temperature. The PVL models with five layers of insulated glass are suitable for low temperature measurements down to -40 or -60 °C when a flow through chiller or cooling thermostat is connected.



Insulated glass makes it possible to observe samples, even at very low temperatures



Removable Command remote control unit for easy and intuitive operation

HEATING PERFORMANCE Heat transfer liquid: Therm 240, bath closed

Bath temperature °C

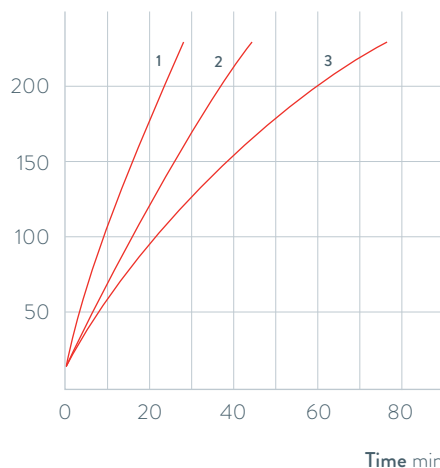

- 1 PV 15 (up to 230 °C)
PVL 15 (up to 100 °C)
- 2 PV 24 (up to 230 °C)
PVL 24 (up to 100 °C)
- 3 PV 36

Important functions

- Programmer with 150 temperature/time segments and graphical temperature display with Command control unit
- LAUDA Vario Flex pump (pressure pump) with eight selectable output levels
- Cooling coil fitted as standard allows connection of an additional cooler

Included accessories

Tubing nipples for pump connection and cooling coil

Further accessories

Solenoid valve for cooling water, additional cooler, interface modules

All technical data and power supply variants can be found in the ›Technical data‹ section.

More at www.lauda.de/1732



LAUDA Proline clear-view thermostats

LAUDA Proline clear-view thermostats are available with two different control units. The master version is designed for all applications in which the parameters are not changed very often. The removable Command operating unit incorporates a graphic LCD screen for high operating convenience and also a programmer.



LAUDA Heating thermostats

Device type overview

LAUDA Alpha / Page 32

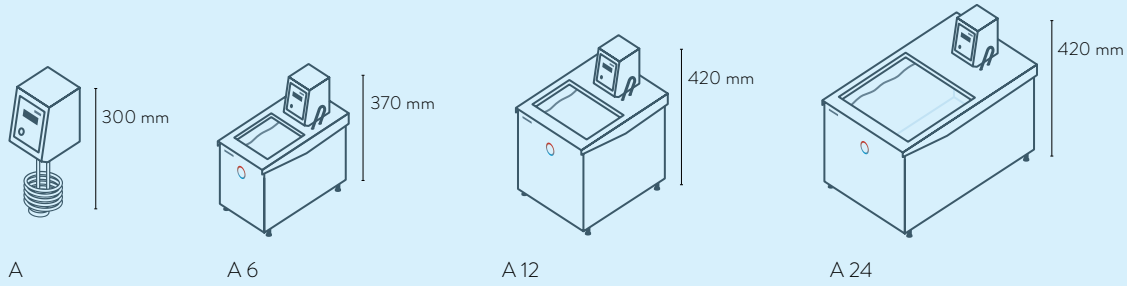

LAUDA ECO / Page 34

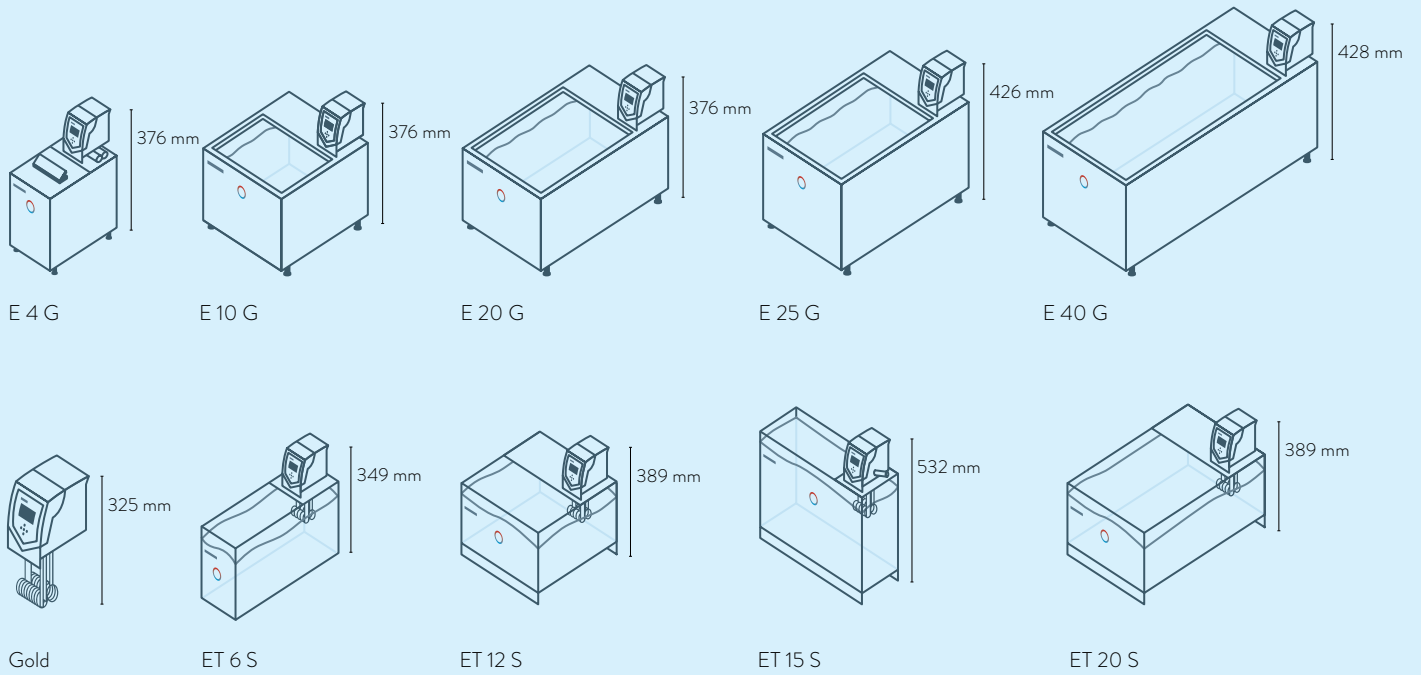

LAUDA PRO / Page 36

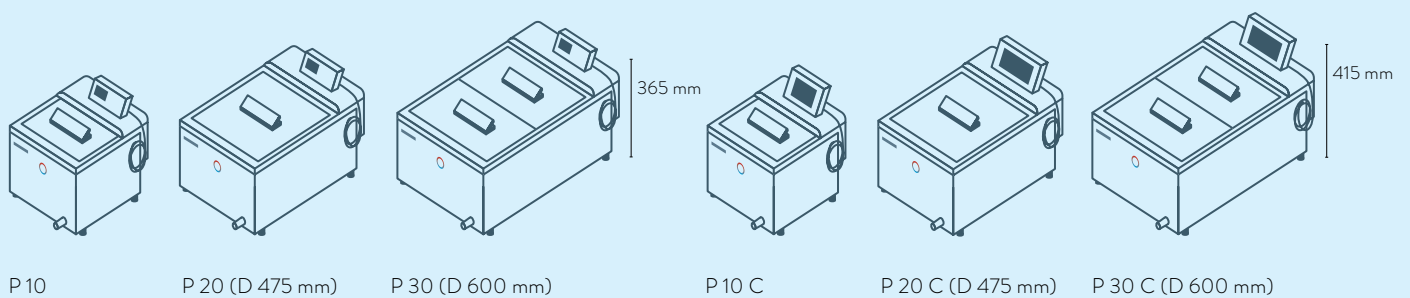

LAUDA Heating thermostats

Interfaces

	Pt 100 (1)	Pt 100 (2)	USB	Ethernet	RS 232 / 485	Analog	Namur contact	Sub-D contact	Profibus	EtherCat M8	EtherCat RJ 45	Number of module slots, large	Number of module slots, small
LAUDA Alpha / Page 32	-	-	-	-	-	-	-	-	-	-	-	-	-
LAUDA ECO / Page 34	Z	-	S	Z	Z	Z	Z	Z	Z	Z	Z	1	1
LAUDA PRO / Page 36	S	-	S	S	Z	Z	Z	Z	Z	Z	Z	1	-
LAUDA Proline Master	S	-	-	Z	Z	Z	Z	Z	Z	Z	Z	2	-
LAUDA Proline Command	S	-	-	Z	S	Z	Z	Z	Z	Z	Z	2	-

S = Series standard

Z = Available as an accessory



LRZ 912
Analog module

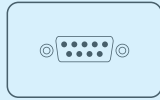

LRZ 913
RS 232/485 interface

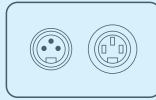

LRZ 914
Contact module with single input and single output (NAMUR)

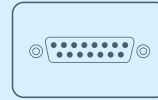

LRZ 915
Contact module with 3 inputs and 3 outputs

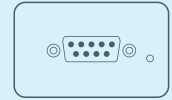

LRZ 917
Profibus module

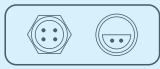

LRZ 918
Pt100/Li bus module, small cover



LRZ 921
Ethernet module

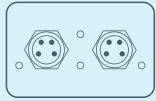

LRZ 922
EtherCAT module with M8 connection

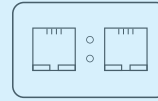

LRZ 923
EtherCAT module with RJ45 connection



LRZ 925
External Pt100/LiBus-module, large cover

LAUDA Proline bridge thermostat / Page 38

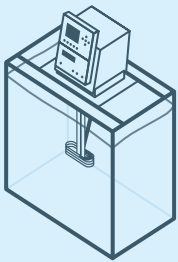

PB C
PBD C

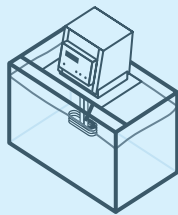

PB
PBD

LAUDA Proline clear-view thermostat / Page 40



PV 15 C
PVL 15 C

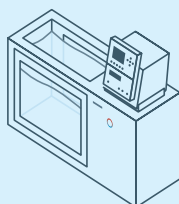

PV 24 C
PVL 24 C

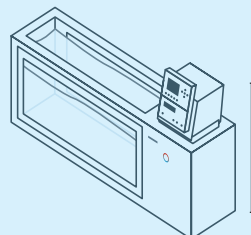

PV 36 C

646 mm



PV 15
PVL 15

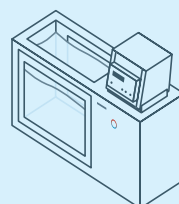

PV 24
PVL 24

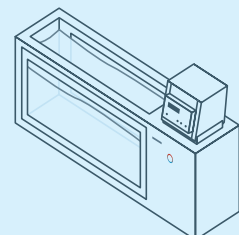

PV 36

646 mm

LAUDA Heating thermostats

Function overview

Operating element	Alpha	ECO S	ECO G	PRO Base	PRO Command Touch	Proline Master	Proline Command
Display	7-Segment	LCD mono	TFT	OLED	TFT	7-Segment	LCD mono
Mode of operation	3-button	3-button softkey	Cursor softkey	Cursor softkey	Multi-touch	4-button	Cursor softkey
Removable control	-	-	-	✓	✓	-	✓
User management	-	-	-	-	✓	-	-
Data logging, export to USB stick	-	-	-	-	✓	-	-
1-point calibration	✓	✓	✓	✓	✓	✓	✓
2-point calibration	-	-	-	✓	✓	-	-
Programmer, programs/segments	-	1 / 20	5 / 150	1 / 20	100 / 5000	-	5 / 150
Programmer, tolerance range function	-	✓	✓	✓	✓	-	✓
Ramp function	-	-	-	-	✓	-	✓
Timer function	-	-	-	-	✓	-	✓
Countdown function	✓	-	-	-	✓	-	✓
Graphic temperature profile display	-	-	✓	-	✓	-	✓
Adjustable bypass	-	-	-	-	-	✓	✓
Level indicator (digital)	-	-	-	✓	✓	✓	✓
Standby timer	-	✓	✓	✓	✓	✓	✓
Low-level alarm	✓	✓	✓	✓	✓	✓	✓
Drain tap	-	✓	✓	✓	✓	✓	✓
Drain screw	✓	-	-	-	-	-	-

LAUDA Heating thermostats

Technical data according to DIN 12876 standard

Device type	Working temperature range °C	Working temperature range with water cooling °C	Operating temperature range °C	Temperature stability ±K	Safety fittings	Heater power max. kW	Pump type	Pump pressure max. bar	Pump suction max. bar	Pump flow max. pressure L./min	Pump flow max. suction L./min	Pump connection thread mm	Nipples Øe	Bath volume min. L
LAUDA Alpha / Page 32														
A	25 ... 100	20 ... 100	-25 ... 100	0.05	I, NFL	1.5	D	0.2	-	15.0	-	N/A	-	-
A 6	25 ... 100	20 ... 100	-25 ... 100	0.05	I, NFL	1.5	D	0.2	-	15.0	-	N/A	-	2.5
A 12	25 ... 100	20 ... 100	-25 ... 100	0.05	I, NFL	1.5	D	0.2	-	15.0	-	N/A	-	8.0
A 24	25 ... 100	20 ... 100	-25 ... 100	0.05	I, NFL	1.5	D	0.2	-	15.0	-	N/A	-	18.0
LAUDA ECO / Page 34														
SILVER	20 ... 200	20 ... 200	-20 ... 200	0.01	III, FL	2.0	V	0.6	-	22.0	-	N/A	-	-
ET 6 S	20 ... 100	20 ... 100	-20 ... 100	0.01	III, FL	2.0	V	0.6	-	22.0	-	N/A	-	5.0
ET 12 S	20 ... 100	20 ... 100	-20 ... 100	0.01	III, FL	2.0	V	0.6	-	22.0	-	N/A	-	9.5
ET 15 S	20 ... 100	20 ... 100	-20 ... 100	0.01	III, FL	2.0	V	0.6	-	22.0	-	N/A	13	13.5
ET 20 S	20 ... 100	20 ... 100	-20 ... 100	0.01	III, FL	2.0	V	0.6	-	22.0	-	N/A	-	15.0
E 4 S	20 ... 200	20 ... 200	-20 ... 200	0.01	III, FL	2.0	V	0.6	-	22.0	-	N/A	13	3.0
E 10 S	20 ... 200	20 ... 200	-20 ... 200	0.01	III, FL	2.0	V	0.6	-	22.0	-	N/A	-	7.5
E 20 S	20 ... 200	20 ... 200	-20 ... 200	0.01	III, FL	2.0	V	0.6	-	22.0	-	N/A	-	13.0
E 25 S	20 ... 200	20 ... 200	-20 ... 200	0.01	III, FL	2.0	V	0.6	-	22.0	-	N/A	-	16.0
E 40 S	20 ... 200	20 ... 200	-20 ... 200	0.01	III, FL	2.0	V	0.6	-	22.0	-	N/A	-	32.0
GOLD	20 ... 200	20 ... 200	-20 ... 200	0.01	III, FL	2.6	V	0.6	-	22.0	-	N/A	-	-
ET 6 G	20 ... 100	20 ... 100	-20 ... 100	0.01	III, FL	2.6	V	0.6	-	22.0	-	N/A	-	5.0
ET 12 G	20 ... 100	20 ... 100	-20 ... 100	0.01	III, FL	2.6	V	0.6	-	22.0	-	N/A	-	9.5
ET 15 G	20 ... 100	20 ... 100	-20 ... 100	0.01	III, FL	2.6	V	0.6	-	22.0	-	M16×1	-	13.5
ET 20 G	20 ... 100	20 ... 100	-20 ... 100	0.01	III, FL	2.6	V	0.6	-	22.0	-	N/A	-	15.0
E 4 G	20 ... 200	20 ... 200	-20 ... 200	0.01	III, FL	2.6	V	0.6	-	22.0	-	M16×1	-	3.0
E 10 G	20 ... 200	20 ... 200	-20 ... 200	0.01	III, FL	2.6	V	0.6	-	22.0	-	N/A	-	7.5
E 20 G	20 ... 200	20 ... 200	-20 ... 200	0.01	III, FL	2.6	V	0.6	-	22.0	-	N/A	-	13.0
E 25 G	20 ... 200	20 ... 200	-20 ... 200	0.01	III, FL	2.6	V	0.6	-	22.0	-	N/A	-	16.0
E 40 G	20 ... 200	20 ... 200	-20 ... 200	0.01	III, FL	2.6	V	0.6	-	22.0	-	N/A	-	32.0

Bath volume max. L	Bath opening (W x D) mm	Bath depth mm	Usable depth mm	Height top of bath mm	Dimensions (W x D x H) mm	Weight kg	Power supply V; Hz	Loading max. kW	Cat. No.	Device type
50.0	-	150	100	-	125×150×300	3.5	230 V; 50/60 Hz	1.5	L000618	A
5.5	145×161	150	130	212	181×332×370	6.2	230 V; 50/60 Hz	1.5	L000619	A 6
12.0	235×161	200	180	262	270×332×420	7.5	230 V; 50/60 Hz	1.5	L000620	A 12
25.0	295×374	200	180	262	332×535×420	10.5	230 V; 50/60 Hz	1.5	L000621	A 24
-	-	150	-	-	130×135×325	3.0	230 V; 50/60 Hz	2.1	L001076	SILVER
6.0	130×285	160	140	169	143×433×349	4.1	230 V; 50/60 Hz	2.1	L001096	ET 6 S
12.0	300×175	160	140	208	322×331×389	6.4	230 V; 50/60 Hz	2.1	L001097	ET 12 S
15.0	275×130	310	290	356	428×148×532	6.4	230 V; 50/60 Hz	2.1	L001098	ET 15 S
20.0	300×350	160	140	208	322×506×389	7.6	230 V; 50/60 Hz	2.1	L001099	ET 20 S
3.5	135×105	150	130	196	168×272×376	6.6	230 V; 50/60 Hz	2.1	L001084	E 4 S
11.0	300×190	150	130	196	331×361×376	8.6	230 V; 50/60 Hz	2.1	L001085	E 10 S
19.0	300×365	150	130	196	331×537×376	11.8	230 V; 50/60 Hz	2.1	L001087	E 20 S
25.0	300×365	200	180	246	331×537×426	13.1	230 V; 50/60 Hz	2.1	L001088	E 25 S
40.0	300×613	200	180	248	350×803×428	17.2	230 V; 50/60 Hz	2.1	L001089	E 40 S
-	-	150	-	-	130×135×325	3.4	230 V; 50/60 Hz	2.7	L001077	GOLD
6.0	130×285	160	140	169	143×433×349	4.5	230 V; 50/60 Hz	2.7	L001100	ET 6 G
12.0	300×175	160	140	208	322×331×389	6.8	230 V; 50/60 Hz	2.7	L001101	ET 12 G
15.0	275×130	310	290	356	428×148×532	6.8	230 V; 50/60 Hz	2.7	L001102	ET 15 G
20.0	300×350	160	140	208	322×506×389	8.0	230 V; 50/60 Hz	2.7	L001103	ET 20 G
3.5	135×105	150	130	196	168×272×376	7.0	230 V; 50/60 Hz	2.7	L001090	E 4 G
11.0	300×190	150	130	196	331×361×376	9.0	230 V; 50/60 Hz	2.7	L001091	E 10 G
19.0	300×365	150	130	196	331×537×376	12.2	230 V; 50/60 Hz	2.7	L001093	E 20 G
25.0	300×365	200	180	246	331×537×426	13.5	230 V; 50/60 Hz	2.7	L001094	E 25 G
40.0	300×613	200	180	248	350×803×428	17.6	230 V; 50/60 Hz	2.7	L001095	E 40 G

LAUDA Heating thermostats

Technical data according to DIN 12876 standard

Device type	Working temperature range °C	Working temperature range with water cooling °C	Operating temperature range °C	Temperature stability ±K	Safety fittings	Heater power max. kW	Pump type	Pump pressure max. bar	Pump suction max. bar	Pump flow max. pressure L /min	Pump flow max. suction L/min	Pump connection thread mm	Nipples Øe	Bath volume min. L
-------------	------------------------------	---	--------------------------------	--------------------------	-----------------	----------------------	-----------	------------------------	-----------------------	--------------------------------	------------------------------	---------------------------	------------	--------------------

LAUDA PRO / Page 36

P 10	40 ... 250	20 ... 250	-30 ... 250	0.01	III, FL	3.6	V	-	-	-	-	N/A	-	5.0
P 20	35 ... 250	20 ... 250	-30 ... 250	0.01	III, FL	3.6	V	-	-	-	-	N/A	-	11.0
P 30	30 ... 250	20 ... 250	-30 ... 250	0.01	III, FL	3.6	V	-	-	-	-	N/A	-	15.0
P 10 C	40 ... 250	20 ... 250	-30 ... 250	0.01	III, FL	3.6	V	-	-	-	-	N/A	-	5.0
P 20 C	35 ... 250	20 ... 250	-30 ... 250	0.01	III, FL	3.6	V	-	-	-	-	N/A	-	11.0
P 30 C	30 ... 250	20 ... 250	-30 ... 250	0.01	III, FL	3.6	V	-	-	-	-	N/A	-	15.0

LAUDA Proline Bridge thermostat / Page 38

PB	30 ... 300	20 ... 300	-30 ... 300	0.01	III, FL	3.6	VF	0.7	0.4	25.0	23	M16×1	13	0.0
PBD	30 ... 300	20 ... 300	-30 ... 300	0.01	III, FL	3.6	V	1.1	-	32.0	-	M16×1	13	0.0
PB C	30 ... 300	20 ... 300	-30 ... 300	0.01	III, FL	3.6	VF	0.7	0.4	25.0	23	M16×1	13	0.0
PBDC	30 ... 300	20 ... 300	-30 ... 300	0.01	III, FL	3.6	V	1.1	-	32.0	-	M16×1	13	0.0

LAUDA Proline Clear-view thermostat / Page 40

PV 15	30 ... 230	20 ... 230	0 ... 230	0.01	III, FL	3.6	V	0.8	-	25.0	-	M16×1	13	11.0
PV 24	30 ... 230	20 ... 230	0 ... 230	0.01	III, FL	3.6	V	0.8	-	25.0	-	M16×1	13	19.0
PV 36	30 ... 230	20 ... 230	0 ... 230	0.01	III, FL	3.6	V	0.8	-	25.0	-	M16×1	13	28.0
PVL 15	30 ... 100	20 ... 100	-60 ... 100	0.01	III, FL	3.6	V	0.8	-	25.0	-	M16×1	13	11.0
PVL 24	30 ... 100	20 ... 100	-60 ... 100	0.01	III, FL	3.6	V	0.8	-	25.0	-	M16×1	13	19.0
PV 15 C	30 ... 230	20 ... 230	0 ... 230	0.01	III, FL	3.6	V	0.8	-	25.0	-	M16×1	13	11.0
PV 24 C	30 ... 230	20 ... 230	0 ... 230	0.01	III, FL	3.6	V	0.8	-	25.0	-	M16×1	13	19.0
PV 36 C	30 ... 230	20 ... 230	0 ... 230	0.01	III, FL	3.6	V	0.8	-	25.0	-	M16×1	13	28.0
PVL 15 C	30 ... 100	20 ... 100	-60 ... 100	0.01	III, FL	3.6	V	0.8	-	25.0	-	M16×1	13	11.0
PVL 24 C	30 ... 100	20 ... 100	-60 ... 100	0.01	III, FL	3.6	V	0.8	-	25.0	-	M16×1	13	19.0

Bath volume max. L	Bath opening (W x D) mm	Bath depth mm	Usable depth mm	Height top of bath mm	Dimensions (W x D x H) mm	Weight kg	Power supply V; Hz	Loading max. kW	Cat. No.	Device type
10.0	240×150	200	180	250	310×335×365	13.5	200-230 V; 50/60 Hz	3.7	L000001	P 10
20.0	300×290	200	180	250	350×475×365	17.0	200-230 V; 50/60 Hz	3.7	L000002	P 20
28.5	340×385	200	180	250	400×600×365	23.0	200-230 V; 50/60 Hz	3.7	L000003	P 30
10.0	240×150	200	180	250	310×335×415	13.5	200-230 V; 50/60 Hz	3.7	L000004	P 10 C
20.0	300×290	200	180	250	350×475×415	17.0	200-230 V; 50/60 Hz	3.7	L000005	P 20 C
28.5	340×385	200	180	250	400×600×415	23.0	200-230 V; 50/60 Hz	3.7	L000006	P 30 C
80.0	-	-	-	-	320×185×400	8.0	230 V; 50/60 Hz	3.7	L001542	PB
80.0	-	-	-	-	320×185×400	8.0	230 V; 50/60 Hz	3.7	L001544	PBD
80.0	-	-	-	-	320×185×576	8.0	230 V; 50/60 Hz	3.7	L001543	PB C
80.0	-	-	-	-	320×185×576	8.0	230 V; 50/60 Hz	3.7	L001545	PBD C
15.0	230×135	320	285	390	506×282×590	26.0	230 V; 50/60 Hz	3.7	L001532	PV 15
24.0	405×135	320	285	390	740×282×590	36.0	230 V; 50/60 Hz	3.7	L001533	PV 24
36.0	585×135	320	285	390	1040×282×590	44.0	230 V; 50/60 Hz	3.7	L001534	PV 36
15.0	230×135	320	285	390	506×282×590	28.0	230 V; 50/60 Hz	3.7	L001538	PVL 15
24.0	405×135	320	285	390	740×282×590	39.0	230 V; 50/60 Hz	3.7	L001539	PVL 24
15.0	230×135	320	285	390	506×282×646	26.0	230 V; 50/60 Hz	3.7	L001535	PV 15 C
24.0	405×135	320	285	390	740×282×646	36.0	230 V; 50/60 Hz	3.7	L001536	PV 24 C
36.0	585×135	320	285	390	1040×282×646	44.0	230 V; 50/60 Hz	3.7	L001537	PV 36 C
15.0	230×135	320	285	390	506×282×646	28.0	230 V; 50/60 Hz	3.7	L001540	PVL 15 C
24.0	405×135	320	285	390	740×282×646	39.0	230 V; 50/60 Hz	3.7	L001541	PVL 24 C

LAUDA Heating thermostats

Power supply variants

Device type	Power supply V; Hz	Heater power max. kW	Loading max. kW	Plug code*	Cat. No.	Device type	Power supply V; Hz	Heater power max. kW	Loading max. kW	Plug code*	Cat. No.
LAUDA Alpha / Page 32											
A	100 V; 50/60 Hz	1.0	1.0	14	L000634	A 12	100 V; 50/60 Hz	1.0	1.0	14	L000636
A	115 V; 60 Hz	1.2	1.2	14	L000630	A 12	115 V; 60 Hz	1.2	1.2	14	L000632
A 6	100 V; 50/60 Hz	1.0	1.0	14	L000635	A 24	100 V; 50/60 Hz	1.0	1.0	14	L000637
A 6	115 V; 60 Hz	1.2	1.2	14	L000631	A 24	115 V; 60 Hz	1.2	1.2	14	L000633
LAUDA ECO / Page 34											
SILVER	100 V; 50/60 Hz	1.0	1.1	14	L001082	E 40 S	100 V; 50/60 Hz	1.0	1.1	14	L001225
SILVER	115 V; 60 Hz	1.3	1.4	14	L001080	E 40 S	115 V; 60 Hz	1.3	1.4	14	L001196
SILVER	220 V; 60 Hz	1.9	2.0	3	L001078	E 40 S	220 V; 60 Hz	1.8	2.1	3	L001176
ET 6 S	100 V; 50/60 Hz	1.0	1.1	14	L001232	GOLD	100 V; 50/60 Hz	1.0	1.1	14	L001083
ET 6 S	115 V; 60 Hz	1.3	1.4	14	L001203	GOLD	115 V; 60 Hz	1.3	1.4	14	L001081
ET 6 S	220 V; 60 Hz	1.8	2.0	3	L001183	GOLD	220 V; 60 Hz	2.4	2.5	3	L001079
ET 12 S	100 V; 50/60 Hz	1.0	1.1	14	L001233	ET 6 G	100 V; 50/60 Hz	1.0	1.1	14	L001236
ET 12 S	115 V; 60 Hz	1.3	1.4	14	L001204	ET 6 G	115 V; 60 Hz	1.3	1.4	14	L001207
ET 12 S	220 V; 60 Hz	1.8	2.7	3	L001184	ET 6 G	220 V; 60 Hz	2.4	2.5	3	L001187
ET 15 S	100 V; 50/60 Hz	1.0	1.1	14	L001234	ET 12 G	100 V; 50/60 Hz	1.0	1.1	14	L001237
ET 15 S	115 V; 60 Hz	1.3	1.4	14	L001205	ET 12 G	115 V; 60 Hz	1.3	1.4	14	L001208
ET 15 S	220 V; 60 Hz	1.8	2.7	3	L001185	ET 12 G	220 V; 60 Hz	2.4	2.5	3	L001188
ET 20 S	100 V; 50/60 Hz	1.0	1.1	14	L001235	ET 15 G	100 V; 50/60 Hz	1.0	1.1	14	L001238
ET 20 S	115 V; 60 Hz	1.3	1.4	14	L001206	ET 15 G	115 V; 60 Hz	1.3	1.4	14	L001209
ET 20 S	220 V; 60 Hz	1.8	2.7	3	L001186	ET 15 G	220 V; 60 Hz	2.4	2.5	3	L001189
E 4 S	100 V; 50/60 Hz	1.0	1.1	14	L001220	ET 20 G	100 V; 50/60 Hz	1.0	1.1	14	L001239
E 4 S	115 V; 60 Hz	1.3	1.4	14	L001191	ET 20 G	115 V; 60 Hz	1.3	1.4	14	L001210
E 4 S	220 V; 60 Hz	1.8	2.1	3	L001171	ET 20 G	220 V; 60 Hz	2.4	2.5	3	L001190
E 10 S	100 V; 50/60 Hz	1.0	1.1	14	L001221	E 4 G	100 V; 50/60 Hz	1.0	1.1	14	L001226
E 10 S	115 V; 60 Hz	1.3	1.4	14	L001192	E 4 G	115 V; 60 Hz	1.3	1.4	14	L001197
E 10 S	220 V; 60 Hz	1.8	2.1	3	L001172	E 4 G	220 V; 60 Hz	2.4	2.5	3	L001177
E 20 S	100 V; 50/60 Hz	1.0	1.1	14	L001223	E 10 G	100 V; 50/60 Hz	1.0	1.1	14	L001227
E 20 S	115 V; 60 Hz	1.3	1.4	14	L001194	E 10 G	115 V; 60 Hz	1.3	1.4	14	L001198
E 20 S	220 V; 60 Hz	1.8	2.1	3	L001174	E 10 G	220 V; 60 Hz	2.4	2.5	3	L001178
E 25 S	100 V; 50/60 Hz	1.0	1.1	14	L001224	E 10 G	100 V; 50/60 Hz	1.0	1.1	14	L001227
E 25 S	115 V; 60 Hz	1.3	1.4	14	L001195	E 10 G	115 V; 60 Hz	1.3	1.4	14	L001198
E 25 S	220 V; 60 Hz	1.8	2.1	3	L001175	E 10 G	220 V; 60 Hz	2.4	2.5	3	L001178

Device type	Power supply V; Hz	Heater power max. kW	Loading max. kW	Plug code*	Cat. No.	Device type	Power supply V; Hz	Heater power max. kW	Loading max. kW	Plug code*	Cat. No.
LAUDA ECO / Page 34											
E 20 G	100 V; 50/60 Hz	1.0	1.1	14	L001229	E 40 G	100 V; 50/60 Hz	1.0	1.1	14	L001231
E 20 G	115 V; 60 Hz	1.3	1.4	14	L001200	E 40 G	115 V; 60 Hz	1.3	1.4	14	L001202
E 20 G	220 V; 60 Hz	2.4	2.5	3	L001180	E 40 G	220 V; 60 Hz	2.4	2.5	3	L001182
E 25 G	100 V; 50/60 Hz	1.0	1.1	14	L001230						
E 25 G	115 V; 60 Hz	1.3	1.4	14	L001201						
E 25 G	220 V; 60 Hz	2.4	2.5	3	L001181						
LAUDA PRO / Page 36											
P 10	100-120 V; 50/60 Hz	1.9	1.9	32	L000554	P 10 C	100-120 V; 50/60 Hz	1.9	1.9	4	L000550
P 10	100-120 V; 50/60 Hz	1.9	1.9	4	L000546	P 10 C	100-120 V; 50/60 Hz	1.9	1.9	32	L000558
P 20	100-120 V; 50/60 Hz	1.9	1.9	4	L000547	P 20 C	100-120 V; 50/60 Hz	1.9	1.9	32	L000559
P 20	100-120 V; 50/60 Hz	1.9	1.9	32	L000555	P 20 C	100-120 V; 50/60 Hz	1.9	1.9	4	L000551
P 30	100-120 V; 50/60 Hz	1.9	1.9	4	L000548	P 30 C	100-120 V; 50/60 Hz	1.9	1.9	32	L000560
P 30	100-120 V; 50/60 Hz	1.9	1.9	32	L000556	P 30 C	100-120 V; 50/60 Hz	1.9	1.9	4	L000552
LAUDA Proline Bridge thermostat / Page 38											
PB	100 V; 50/60 Hz	1.3	1.5	4	L001590	PBC	100 V; 50/60 Hz	1.3	1.5	4	L001591
PB	115 V; 60 Hz	1.7	1.9	4	L001580	PBC	115 V; 60 Hz	1.7	1.9	4	L001581
PBD	100 V; 50/60 Hz	1.3	1.5	4	L001592	PBD C	100 V; 50/60 Hz	1.3	1.5	4	L001593
PBD	115 V; 60 Hz	1.7	1.9	4	L001582	PBD C	115 V; 60 Hz	1.7	1.9	4	L001583
LAUDA Proline Clear-view thermostat / Page 40											
PV 15	100 V; 50/60 Hz	1.3	1.5	4	L001584	PV 15 C	100 V; 50/60 Hz	1.3	1.5	4	L001585
PV 15	115 V; 60 Hz	1.7	1.9	4	L001574	PV 15 C	115 V; 60 Hz	1.7	1.9	4	L001575
PV 24	200 V; 50/60 Hz	2.7	2.9	3	L001594	PV 24 C	200 V; 50/60 Hz	2.7	2.9	3	L001596
PV 24	208-220 V; 60 Hz	3.3	3.5	3	L001598	PV 24 C	208-220 V; 60 Hz	3.3	3.5	3	L001600
PV 36	200 V; 50/60 Hz	2.7	2.9	3	L001595	PV 36 C	200 V; 50/60 Hz	2.7	2.9	3	L001597
PV 36	208-220 V; 60 Hz	3.3	3.5	3	L001599	PV 36 C	208-220 V; 60 Hz	3.3	3.5	3	L001601
PVL 15	100 V; 50/60 Hz	1.3	1.5	4	L001586	PVL 15 C	100 V; 50/60 Hz	1.3	1.5	4	L001588
PVL 15	115 V; 60 Hz	1.7	1.9	4	L001576	PVL 15 C	115 V; 60 Hz	1.7	1.9	4	L001578
PVL 24	100 V; 50/60 Hz	1.3	1.5	4	L001587	PVL 24 C	100 V; 50/60 Hz	1.3	1.5	4	L001589
PVL 24	115 V; 60 Hz	1.7	1.9	4	L001577	PVL 24 C	115 V; 60 Hz	1.7	1.9	4	L001579

*All data for the plug codes can be found on page 150

LAUDA Heating thermostats

More characteristics

LAUDA Alpha / Page 32

PUMP CHARACTERISTIC Water

Pressure bar

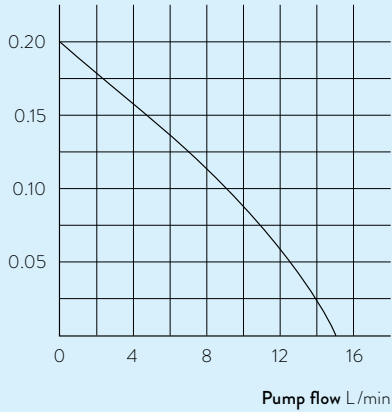

LAUDA ECO / Page 34

HEATING PERFORMANCE Heat transfer liquid: Therm 240, bath closed

Bath temperature °C

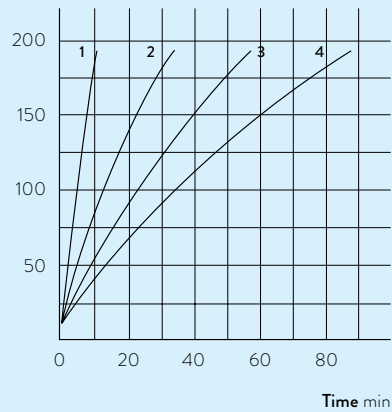

- 1 E 4 S
- 2 E 10 S
- 3 E 20 S
- 4 E 25 S

HEATING PERFORMANCE Heat transfer liquid: Water, bath closed

Bath temperature °C

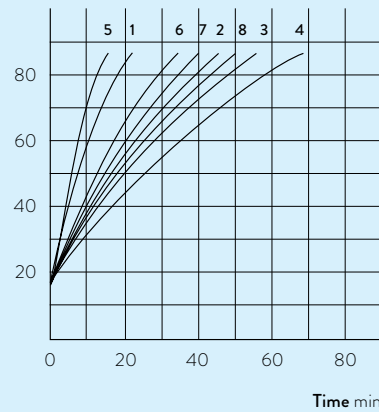

- 1 ET 6 S
- 2 ET 12 S
- 3 ET 15 S
- 4 ET 20 S
- 5 ET 6 G
- 6 ET 12 G
- 7 ET 15 G
- 8 ET 20 G

PUMP CHARACTERISTIC Water

Pressure bar

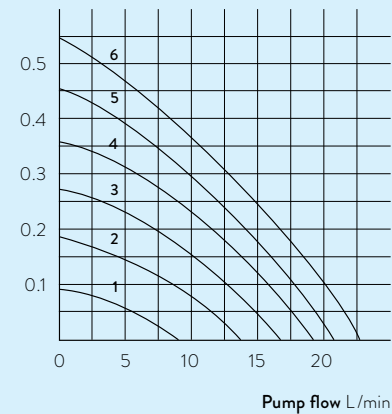

- 1 Step 1
- 2 Step 2
- 3 Step 3
- 4 Step 4
- 5 Step 5
- 6 Step 6

PUMP CHARACTERISTIC for PB and PBC, Water

Pressure bar

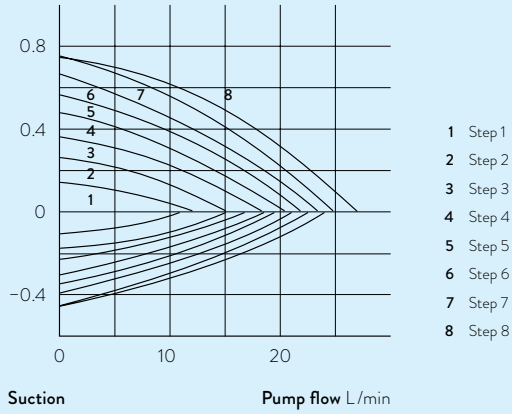

PUMP CHARACTERISTIC for PBD and PBD C, Water

Pressure bar

